

Varenummer: 207321M81012ST
Beskrivelse: E+G Pasbolt
GN 732.1-M8-10-12-ST

Mål

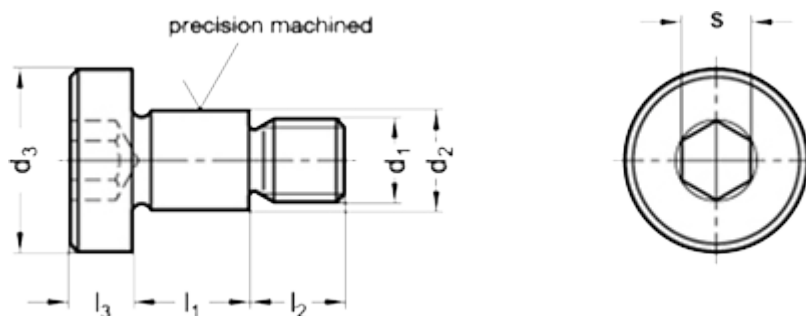

Application example



d1	= M 8
d2	= 10 -0.05/-0.08
d3	= 16
$l_1 +0.20/+0.13$	= 12
l_2	= 11
l_3	= 5
s	= 5
Vægt i (g)	= 17